

ART.NR. 280800

1/6

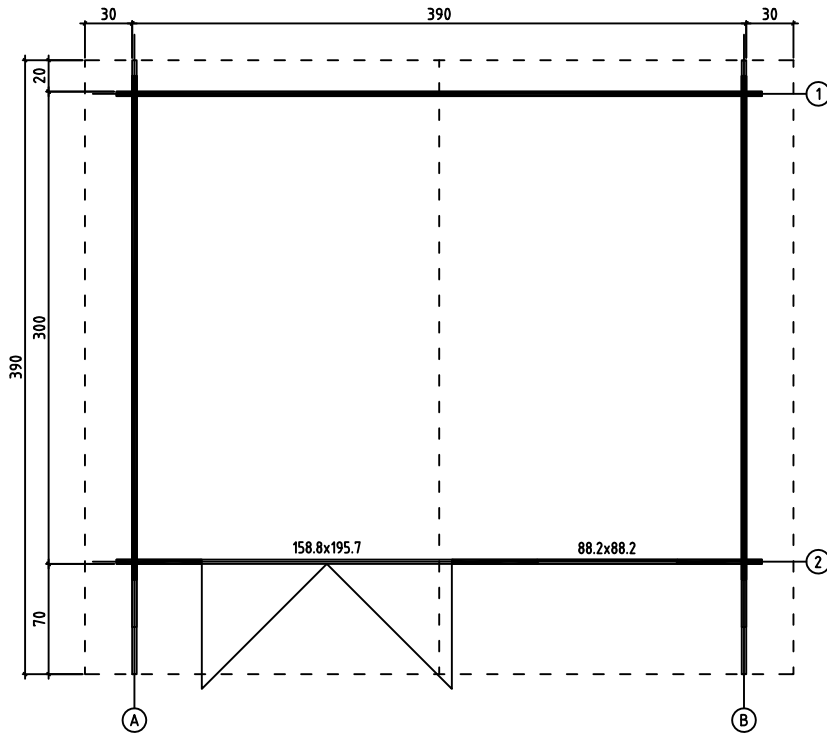

GROUNDPLAN - GRUNDPLAN - PLAN DE MASSE





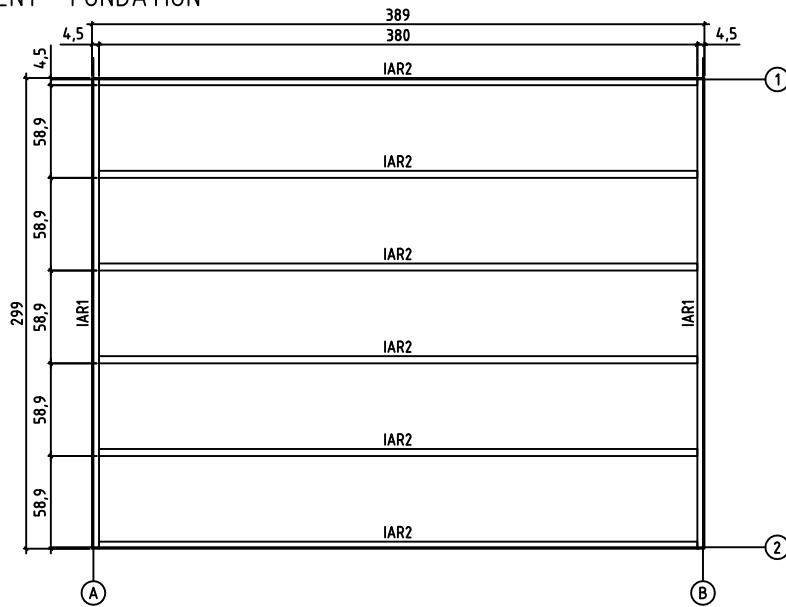



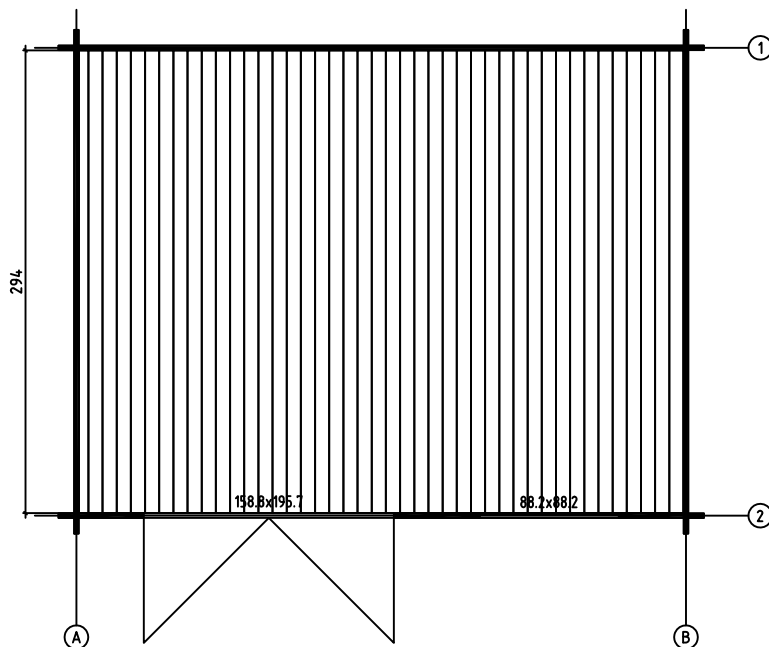

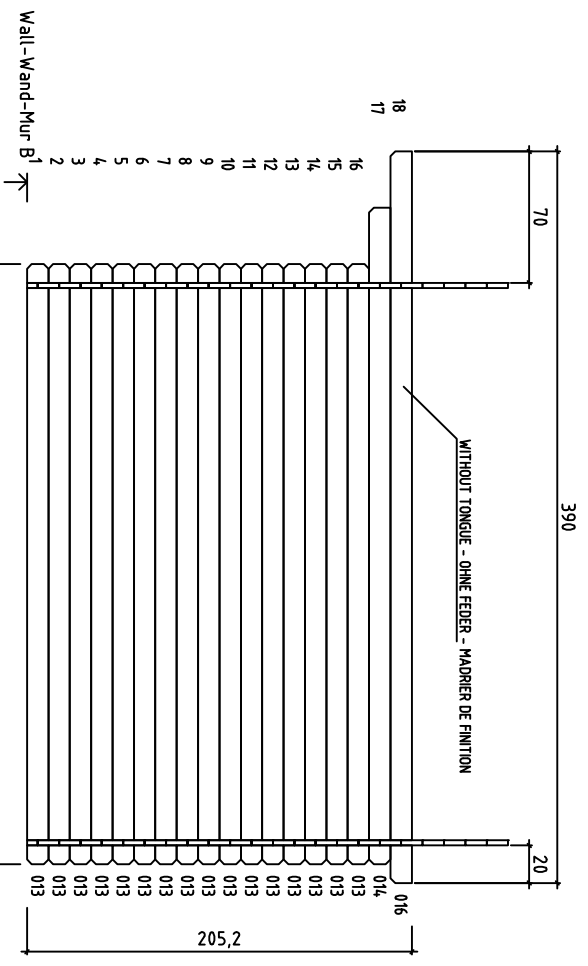
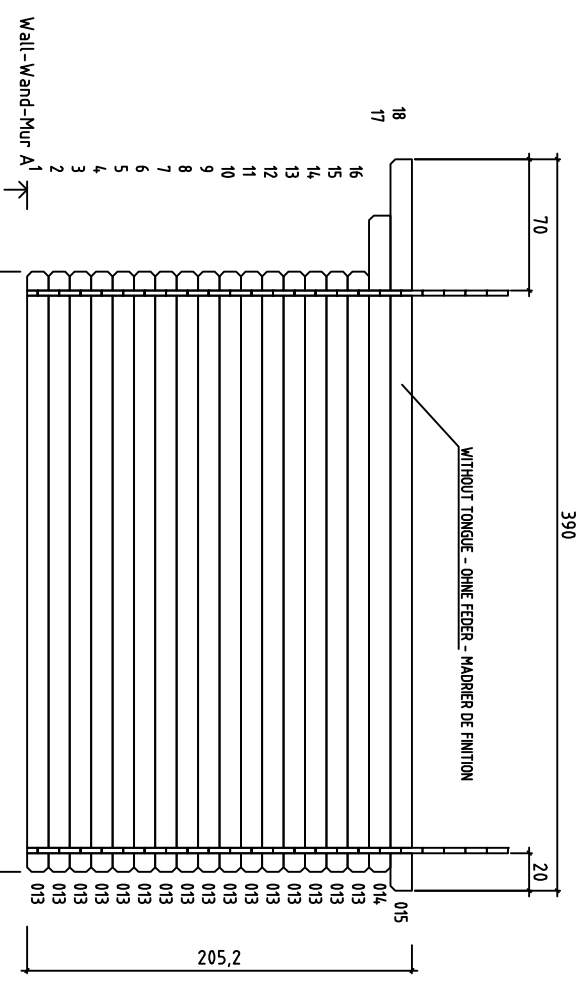
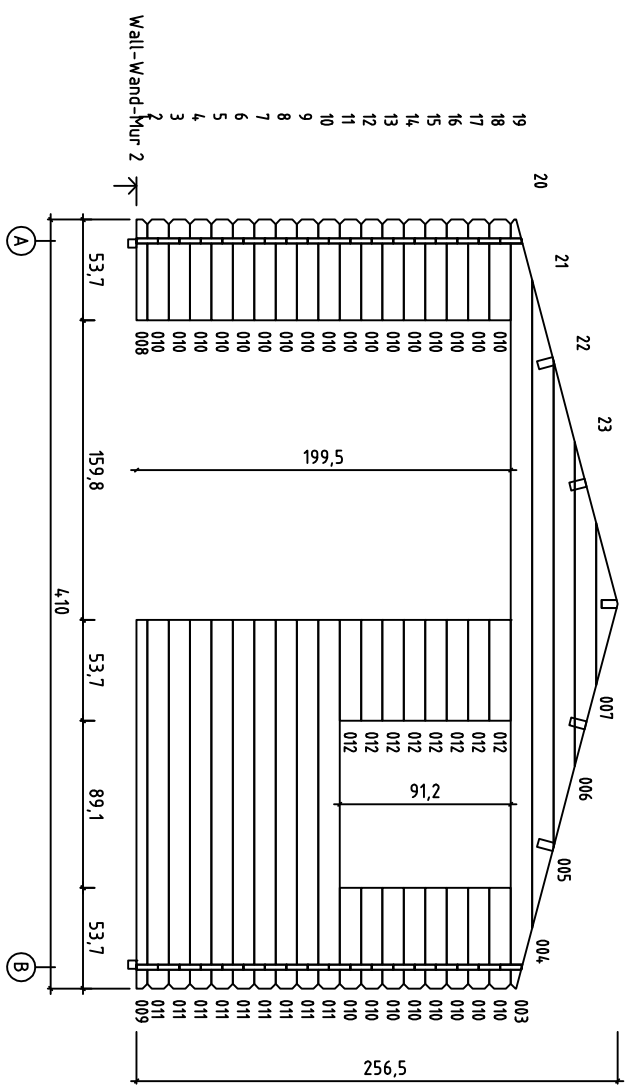
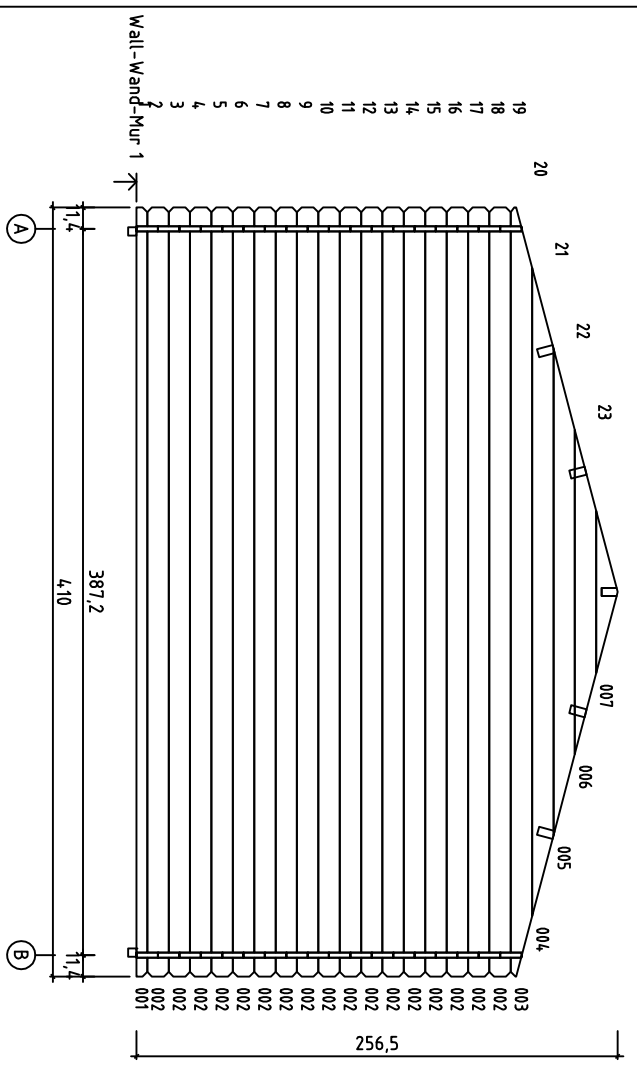

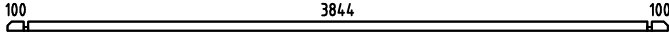
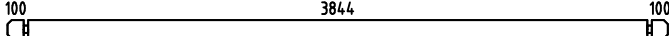

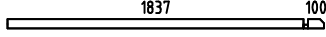
FOUNDATION - FUNDAMENT - FONDATION

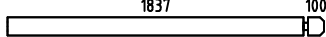

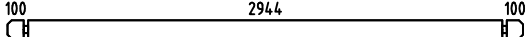
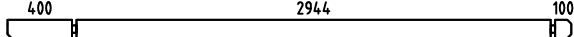
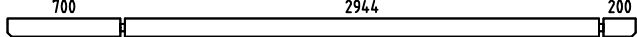
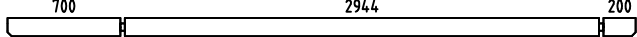
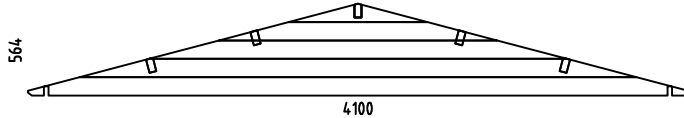
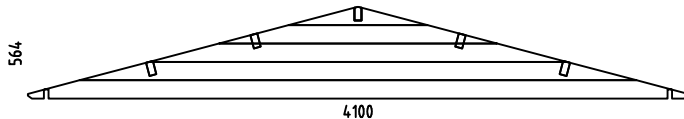
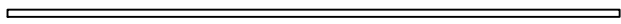
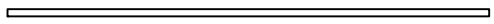
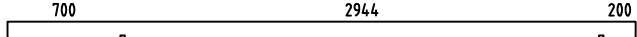
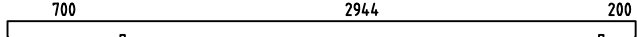



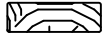



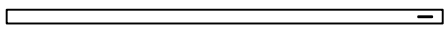
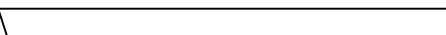

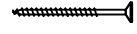
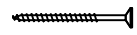
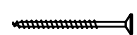
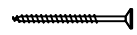

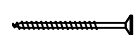



FLOOR BOARDS - FUSSBODENBRETTER - PLAN POSE PLANCHER

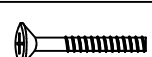

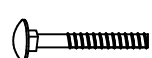

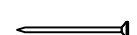
Pos	07.05.2010	ART.NR. 280800	4/6	Q.	P (mm)	L (mm)
001				1	28x57	4100
002				17	28x114	4100
008				1	28x57	537
009				1	28x57	1965
010				25	28x114	537
011				9	28x114	1965
012				8	28x114	537
013				32	28x114	3200
014				2	28x114	3500
015				1	28x120	3900
016				1	28x120	3900
W1-1				1		
W2-1				1		
IAR2	FOUNDATION - FUNDAMENT - FONDATION 			6	45x45	3800
IAR1	FOUNDATION - FUNDAMENT - FONDATION 			2	45x45	2990
PR11	ROOF BEAM - DACHBALKEN - PANNE DE TOIT 			1	44x140	3900
PR21	ROOF BEAM - DACHBALKEN - PANNE DE TOIT 			4	44x140	3900
	FLOOR BOARDS - FUSSBODENBRETTER - LAME DE PLANCHER 			43	90x18	2940
	ROOF BOARDS - DACHBRETTER - VOLIGES 			88	90x18	2300
	FLOOR FILLET - FUSSBODENLEISTE - CORNIERE DE FINITION DU PLANCHER 				18x18	13.56
	ROOFING FELT FILLET - DACHPAPPENLEISTE - BAGUETTE DE FIXATION DU FEUTRE BITUMEUX 			4	18x58	2350
	EAVES BOARD - TRAUFBRETT - BANDEAU DE TOIT 			2	18x90	3900
	ROOF EDGE REINFORCEMENT - DACHRANDVERSTÄRKUNG - CORNIERE DE RENFORT DE BORD DE TOIT 			2	28x34	3900

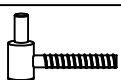
Pos	07.05.2010	ART.NR. 280800	5/6	Q.	P (mm)	L (mm)
	STORM PROTECTION - STURMLEISTE - LATTE ANTI-TEMPETE			4	22x45	2000
	GABLE MOULDING - GIEBELLEISTE - PLANCHE DE RIVE			4	18x120	2350
	WINDOW HANDLE FITTINGS-FENSTERGRIFF - POIGNÉE D'OUVERTURE DE FENETRE			1		
	SCREW FOR GABLE SEGMENT - SCHRAUBEN FÜR DECKBLATT - VIS POUR FIXATION LOSANGE DE FINITION			4	3.5x35	
	SCREW FOR GABLE MOULDING - SCHRAUBEN FÜR GIEBELLEISTE - VIS DE FIXATION POUR PLANCHE DE RIVE			32	3.5x50	
	SCREW FOR FILLET - SCHRAUBE ZUR BEFESTIGUNG TÜRLEISTE - VIS D'ASSEMBLAGE DU CADRE DE PORTE			5	3x30	
	SCREW FOR EAVES BOARDS - SCHRAUBEN FÜR TRAUFBRETT - VIS DE FIXATION POUR BANDEAU DE TOIT			18	4x40	
	SCREW FOR ROOF EDGE REINFORCEMENT - SCHRAUBEN FÜR DACHRANDVERSTÄRKUNG - VIS POUR RENFORT DE BORD DE TOIT			18	4x40	
	SCREW FOR ROOF BEAMS - SCHRAUBEN FÜR DACHBALKEN - VIS POUR PANNE DE TOIT			14	5x120	
	SCREW FOR 1. WALL BEAM - SCHRAUBE FÜR 1. BOHLENREIHE - VIS DE FIXATION DES FONDATIONS			5	5x90	
	SCREW FOR FUNDAMENT - SCHRAUBEN ZUR BEFESTIGUNG FUNDAMENT - VIS POUR FONDATION			12	5x90	
	SCREW FOR DOOR JAMB - SCHRAUBE FÜR TÜRRAHMEN - VIS DE FIXATION POUR MONTANT DE PORTE			4	5x90	
	ZN NAIL FOR FLOOR FILLET - ZN NÄGEL FÜR FUSSBODENLEISTE - POINTE POUR CORNIERE DE FINITION DU PLANCHER			27	1.4x40	
	HAMMER BLOCK - SCHLAGHOLZ - CALLE DE FRAPPE			1		
	SCREW FOR DOORSTEP - SCHRAUBEN FÜR SWELLE - VIS DE FIXATION DU SEUIL DE PORTE			3	4.5x65	
	ZN NAIL FOR ROOFING FELT FILLET - ZN NÄGEL FÜR DACHPAPPENLEISTE - POINTE POUR BAGUETTE FIXATION FEUTRE BITUMEUX			24	2x40	
	BOLT FOR WINDOW HANDLE FITTINGS - BOLZEN FÜR FENSTERGRIFF BESCHLAG - BOULON POUR POIGNÉE D'OUVERTURE DE FENETRE			2		
	GABLE SEGMENT-DECKBLATT - LOSANGE DE FINITION			2		
	NUT FOR STORM PROTECTION - SCHRAUBENMUTTER FÜR STURMLEISTE - ÉCROU POUR LAME ANTI-TEMPETE			8		
	BOLT FOR STORM PROTECTION - BOLZEN FÜR STURMLEISTE - VIS POUR LAME ANTI-TEMPETE			8		
	WASHER FOR STORM PROTECTION - DICHTSCHEIBE FÜR STURMLEISTE - RONDELLE POUR LAME ANTI-TEMPETE			8		
	ZN NAIL FOR ROOF - ZN NÄGEL FÜR DACHBRETT - POINTE POUR TOIT			372	2x50	
	ZN NAIL FOR FLOOR - ZN NÄGEL FÜR FUSSBODENBRETT - CLOUS POUR PLANCHER			264	2x50	
	SET OF DOOR LOCK COVERS - SCHLOSSBLENDEN - SET DE GARNITURES DE SERRURE DE PORTE			1		
	MALE BOLT HINGE FOR DOOR - TÜRRIEGEL - PARTIE MALE DE CHARNIERE DE PORTE			6		

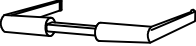
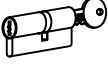
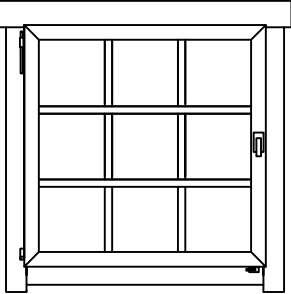
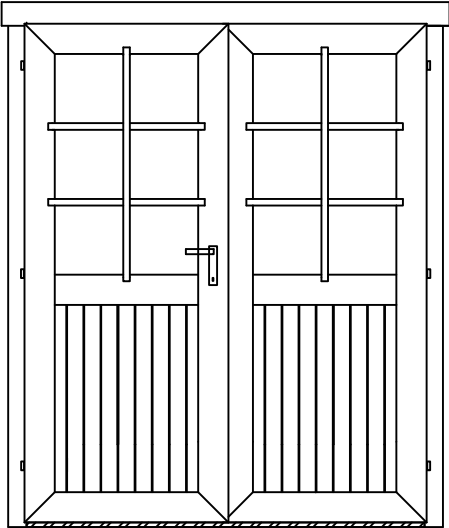
Pos	07.05.2010	ART.NR. 280800	6/6	Q.	P (mm)	L (mm)
	DOOR HANDLE FITTINGS-TÜRGRIF - SET DE GARNITURES DE SERRURE DE PORTE			1		
	CYLINDER -ZYLINDERSCHLOSS - CYLINDRE DE SERRURE			1		
	WINDOW-FENSTER-FENETRE 882x882		AK.1.109.SSV.b 	1		
	DOOR-TÜR-PORTE 1588x1957		TUK.2.056.SVV.MMa 	1		