

# Model Enø

1/5

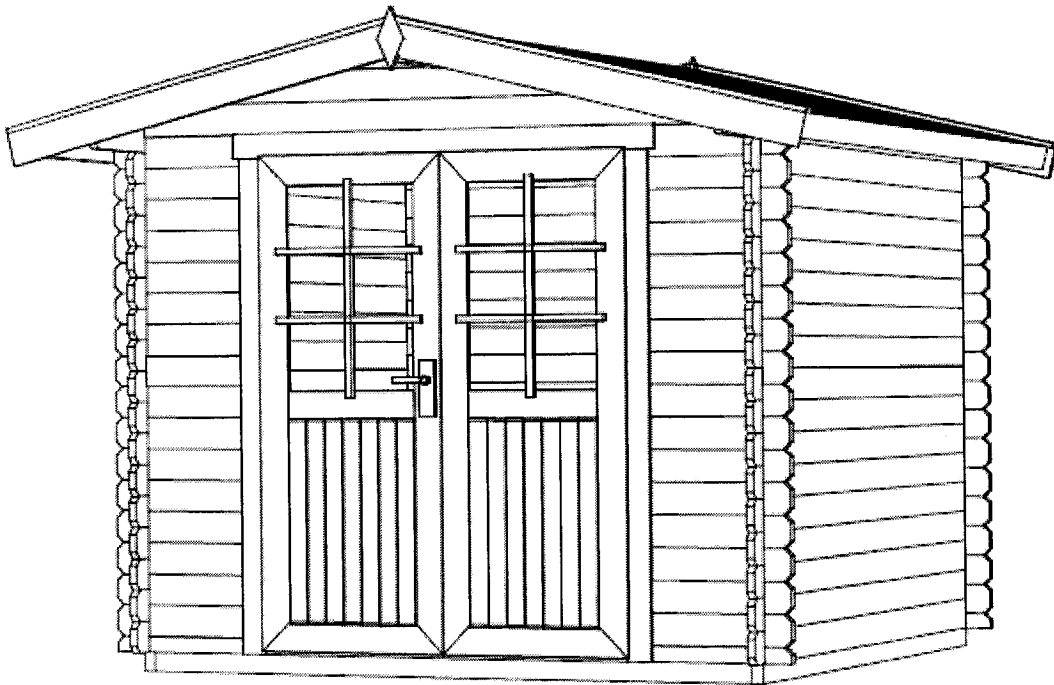

Model Enø

GRUNDPLAN  
GRUNDPLAN

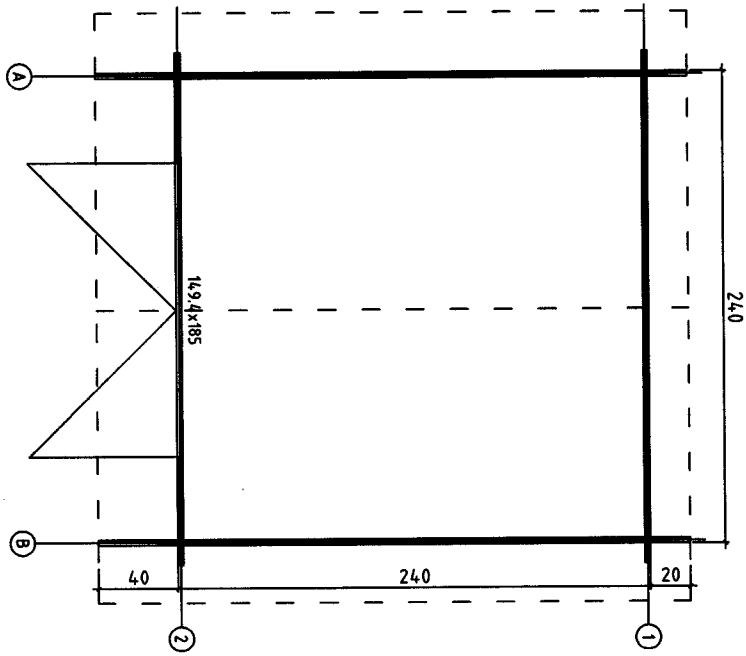

FOUNDATION  
FUNDAMENT

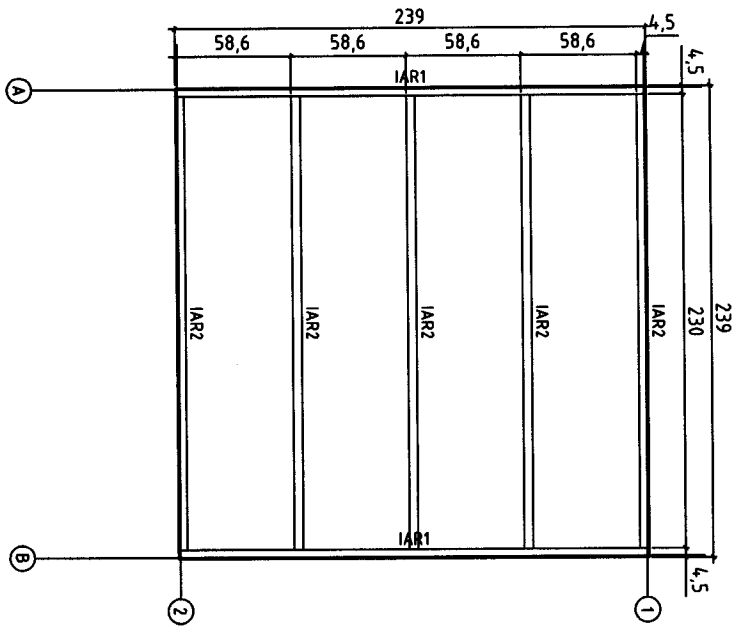



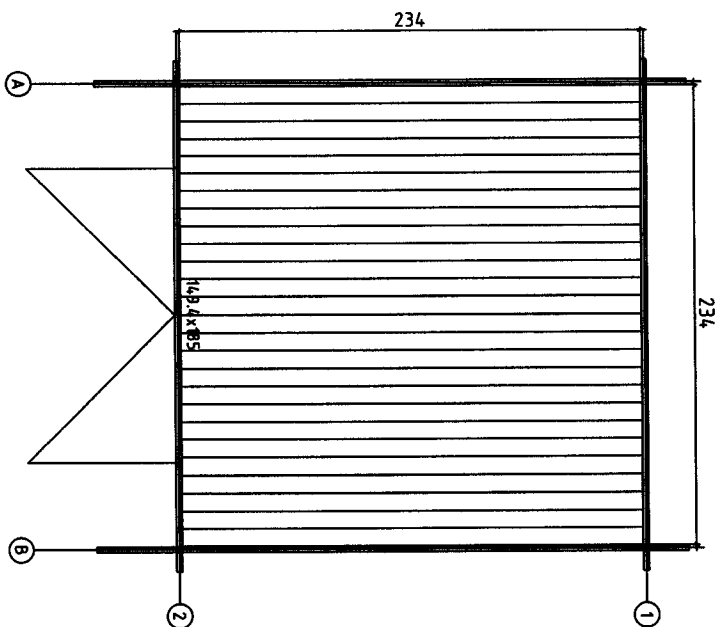



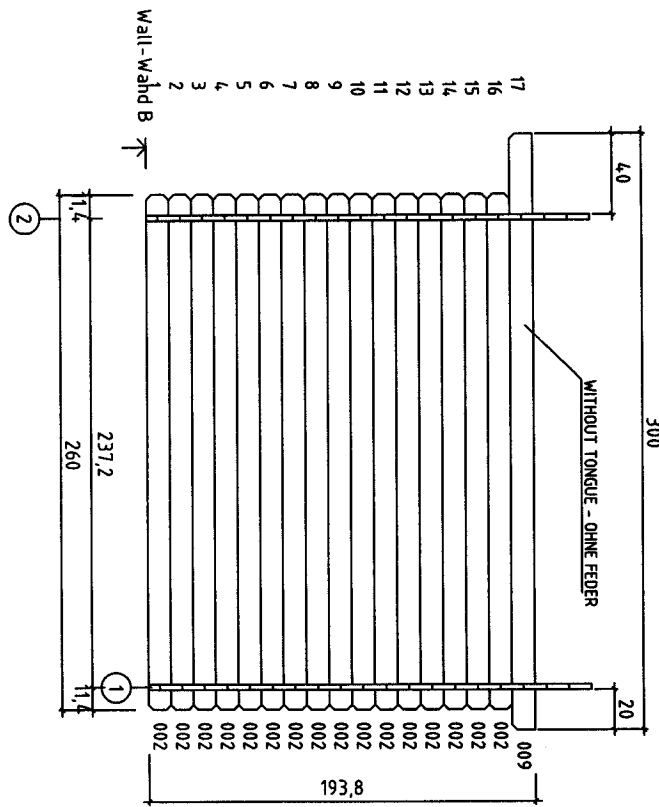
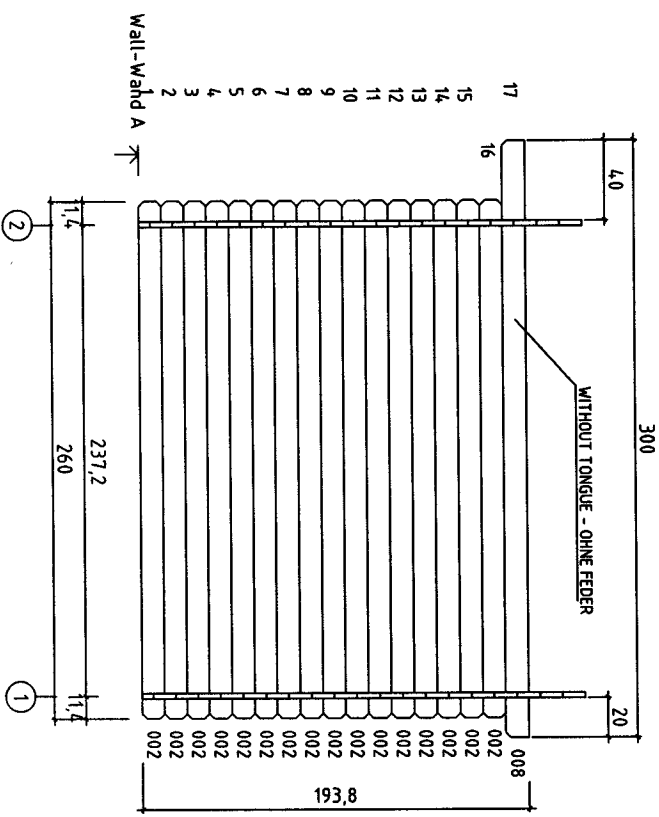
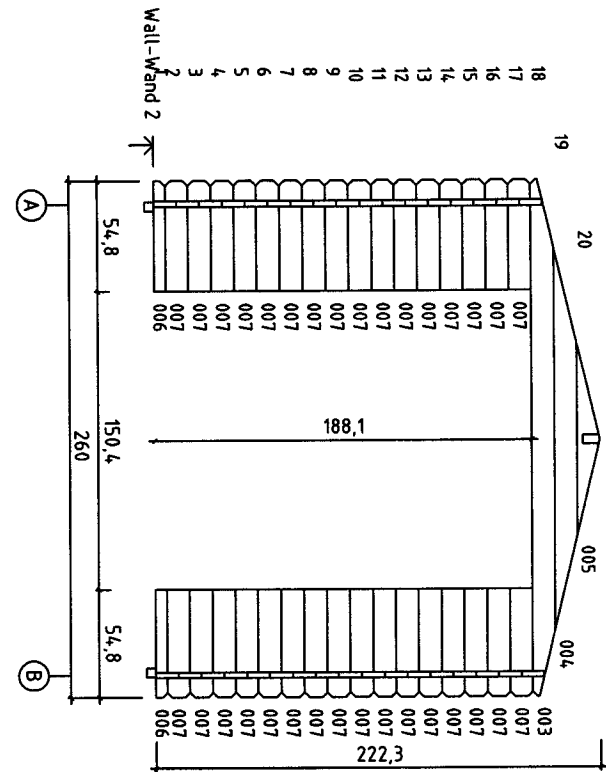
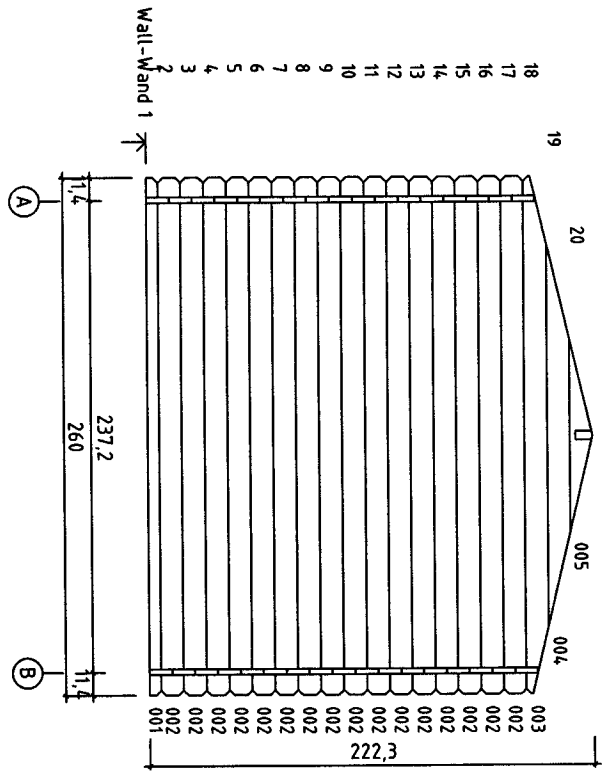

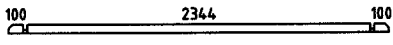
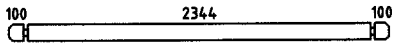

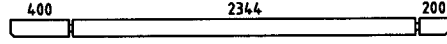
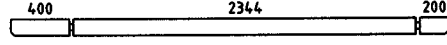
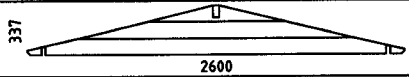
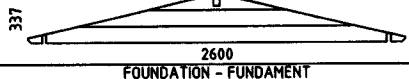

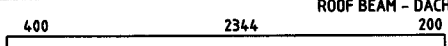



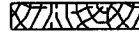

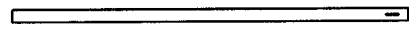
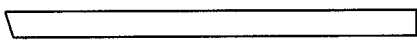



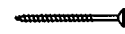



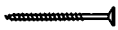

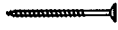
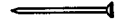
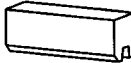
FLOOR BOARDS  
FUSSBODENBRETTTER

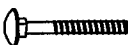

# Model Enø

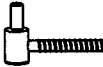

Pos	08.03.2009	Model Enø	4/5	St.	Profile (mm)	Lenght (mm)
001				1	28x57	2600
002				48	28x114	2600
006				2	28x57	548
007				32	28x114	548
008				1	28x120	3000
009				1	28x120	3000
W1-1				1		
W2-1				1		
IAR1		FOUNDATION - FUNDAMENT		2	45x45	2390
IAR2		FOUNDATION - FUNDAMENT		5	45x45	2300
PR11		ROOF BEAM - DACHBALKEN		1	44x120	3000
	FLOOR BOARDS - FUSSBODENBRETTER			26	90x18	2340
	ROOF BOARDS - DACHBRETTER			68	90x18	1500
	FLOOR FILLET-FUSSBODENLEISTE				18x18	9.36
	ROOFING FELT FILLET - DACHPAPPENLEISTE			4	18x58	1550
	EAVES BOARD - TRAUFBRETT			2	18x90	3000
	ROOF EDGE REINFORCEMENT - DACHRANDVERSTÄRKUNG			2	28x34	3000
	STORM PROTECTION-STURMLEISTE			4	22x45	1900
	GABLE MOULDING - GIEBELLEISTE			4	18x120	1550
	SCREW FOR GABLE SEGMENT - SCHRAUBEN FÜR DECKBLATT			4	3.5x35	
	SCREW FOR GABLE MOULDING - SCHRAUBEN FÜR GIEBELLEISTE			16	3.5x50	
	SCREW FOR DOORSTEP - SCHRAUBEN FÜR SWELLE			3	4.5x65	
	SCREW FOR FILLET - SCHRAUBE ZUR BEFESTIGUNG TÜRLEISTE			5	3x30	
	SCREW FOR EAVES BOARDS - SCHRAUBEN FÜR TRAUFBRETTER			14	4x40	
	SCREW FOR ROOF EDGE REINFORCEMENT - - SCHRAUBEN FÜR DACHRANDVERSTÄRKUNG			14	4x40	

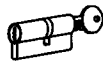
Pos	08.03.2009	Model Enø	5/5	St.	Profile (mm)	Lenght (mm)
	SCREW FOR ROOF BEAMS - SCHRAUBEN FÜR DACHBALKEN			6	5x120	
	SCREW FOR 1. WALL BEAM - SCHRAUBE FÜR 1. BOHLENREIHE			6	5x90	
	SCREW FOR FUNDAMENT - SCHRAUBEN ZUR BEFESTIGUNG FUNDAMENT			10	5x90	
	SCREW FOR DOOR JAMB - SCHRAUBE FÜR TÜRRAHMEN			4	5x90	
	ZN NAIL FOR FLOOR FILLET - ZN NÄGEL FÜR FUSSBODENLEISTE			20	1.4x40	
	HAMMER BLOCK - SCHLAGHOLZ			1		
	ZN NAIL FOR ROOFING FELT FILLET - ZN NÄGEL FÜR DACHPAPPENLEISTE			16	2x40	
	GABLE SEGMENT-DECKBLATT			2		
	NUT FOR STORM PROTECTION - SCHRAUBENMUTTER FÜR STURMLEISTE			8		
	BOLT FOR STORM PROTECTION - BOLZEN FÜR STURMLEISTE			8		
	WASHER FOR STORM PROTECTION - DICHTSCHEIBE FÜR STURMLEISTE			8		
	ZN NAIL FOR ROOF - ZN NÄGEL FÜR DACHBRETT			144	2x50	
	ZN NAIL FOR FLOOR - ZN NÄGEL FÜR FUSSBODENBRETT			135	2x50	
	SET OF DOOR LOCK COVERS - SCHLOSSBLENDEN			1		
	MALE BOLT HINGE FOR DOOR 16/44 - TÜRRIEGEL 16/44			6		
	DOOR HANDLE FITTINGS-TÜRGRIF			1		
	CYLINDER-ZYLINDERSCHLOSS			1		
	DOOR-TÜR 1494x1850	TUK.2.056.SVV.MMc		1		
